

 **MISUTONIDA**
  *italian style* **4x4**
accessories

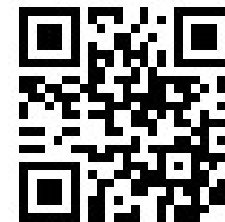

TOYOTA HI-LUX DOUBLE CAB 2016



60 Min.

Item Code

Codice Articolo

Référence Article

GP/410/IX

GB

STAINLESS STEEL
GRAND PEDANA

ITA











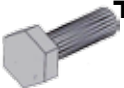



GRAND PEDANA
IN ACCIAIO INOX

FR

GRAND PEDANA
EN ACCIER INOX

TOYOTA HI-LUX DOUBLE CAB 2016

Part List
 Lista della bulloneria
 Liste des pièces

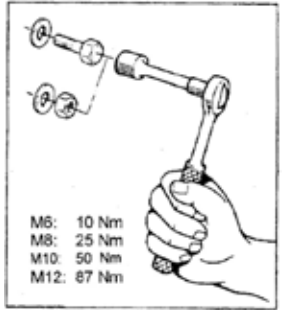
A  TE M10X25 x 8	B  Ø 10 x 8	C  Ø 10 x 8	D  M10 x 8	E  M 8 x 2
F  TE M8X30 x 4	G  BIG Ø 8 GRANDE GRAND x 16	H  Ø 8 x 16	I  TE M8X20 x 8	L  GP/410/A x 4
M  P/410/B x 2	N  P/410/C x 2	 Cappelletti M10 x 16	 Cappelletti M 8 x 8	 <p>M5: 10 Nm M8: 25 Nm M10: 50 Nm M12: 87 Nm</p>

TOYOTA HI-LUX DOUBLE CAB 2016

*lubricate the set of bolts
supplied before tightening
them*



*Si consiglia di lubrificare
la bulloneria in dotazione
prima del settaggio*

*Lubrifier la boulonnerie fournie
avant de la serrer*

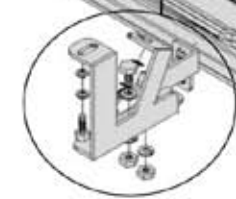
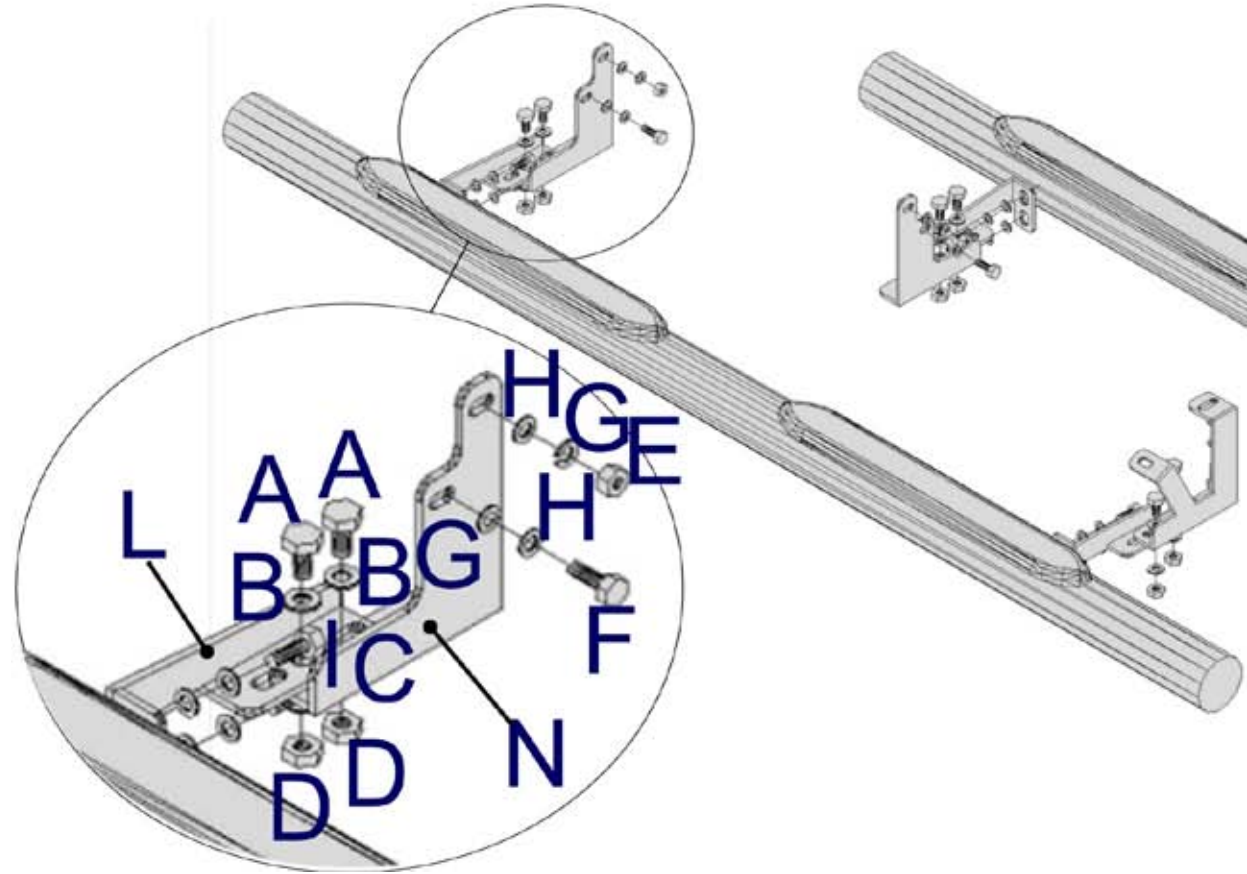
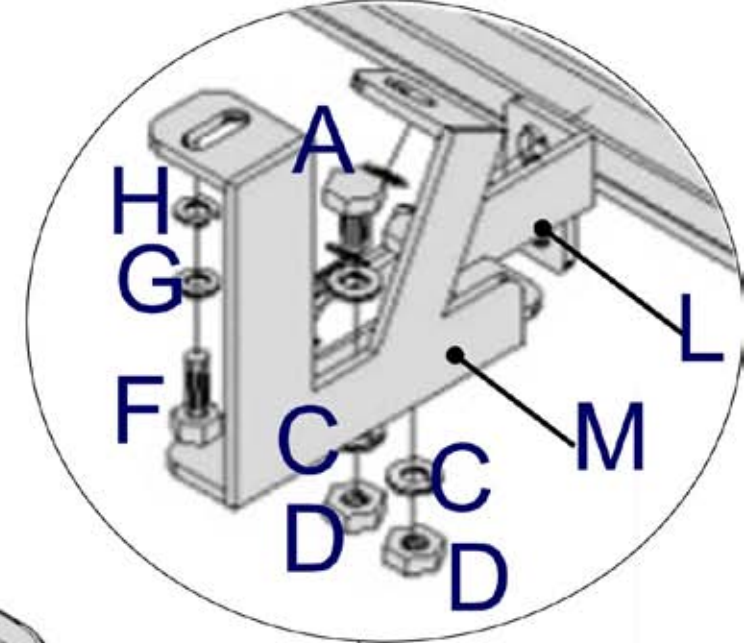



1



2



3



4



5



6

Date Data Date Datum	Item Code Cod.Articolo Réf. Article Artikelbezeichnung	Vehicle model Modello Veicolo Modèle de Voiture Fahrzeugmodell
06/06/16	GP/410/IX	HI-LUX DOUBLE CAB 2016

Document checked and approved by
Documento controllato ed approvato da
 Document contrôlé et approuvé par
 Dokument überprüft und freigegeben durch

BOTTA PIETRO



Date Data Date Datum	Item Code Cod.Articolo Réf. Article Artikelbezeichnung	Vehicle model Modello Veicolo Modèle de Voiture Fahrzeugmodell
06/06/16	GP/410/IX	HI-LUX DOUBLE CAB 2016

Document checked and approved by
Documento controllato ed approvato da
Document contrôlé et approuvé par
Dokument überprüft und freigegeben durch

BOTTA PIETRO