

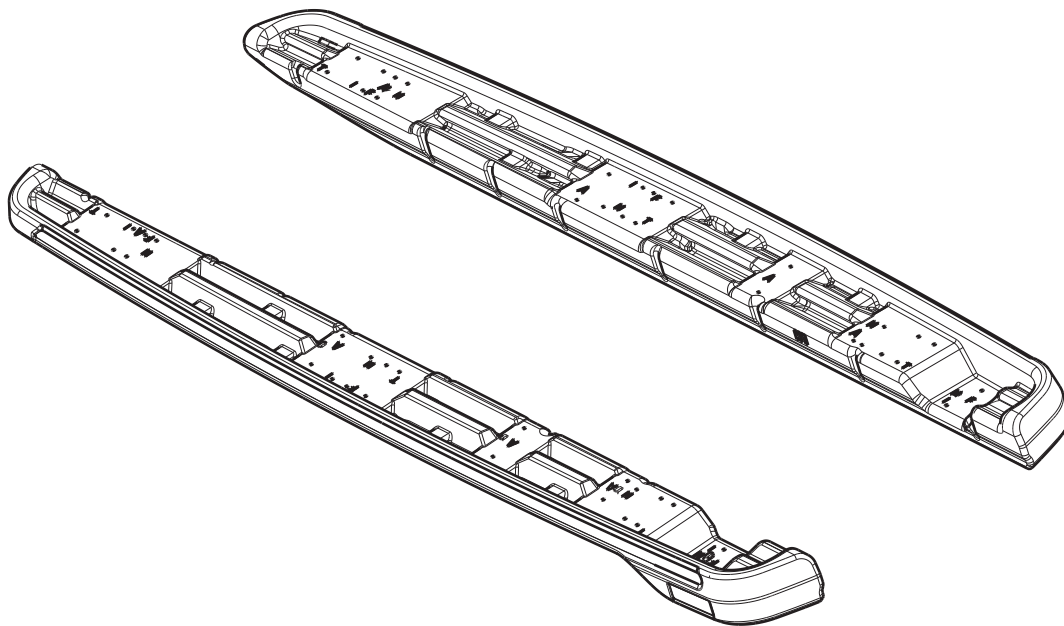

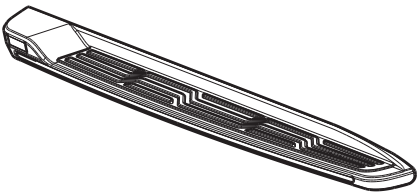

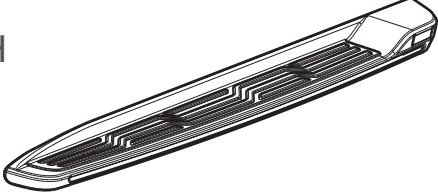



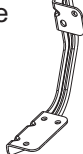

Für :
For : **NISSAN NAVARA**



<p>A RE RH</p>  <p>X 1</p>	<p>B LI LH</p>  <p>X 1</p>		
<p>C FORNT Vorne</p>  <p>X 4</p>	<p>D MIDDLE Mitte</p>  <p>X 2</p>	<p>E REAR (LH) Hinten (RE)</p>  <p>X 1</p>	<p>F REAR (RH) Hinten (LI)</p>  <p>X 1</p>
<p>G M 6 Schraube M 6</p>  <p>X12</p>	<p>H Nut stud M 8 Kontermutter M 8</p>  <p>X12</p>	<p>I M 6 (washer) OD 16 mm M6 (Unterlegscheibe) OD 16 mm</p>  <p>X12</p>	<p>J Nut stud M 6 Kontermutter M 6</p>  <p>X2</p>
	<p>319121300001</p>	<p>25/09/2017</p>	<p>2/5</p>

1

Mit Fahrzeugschrauben
With vehicle screw

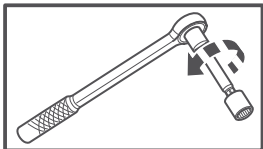
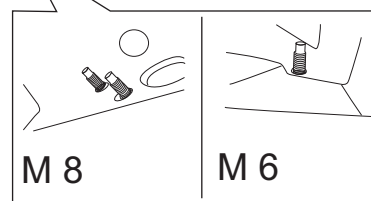
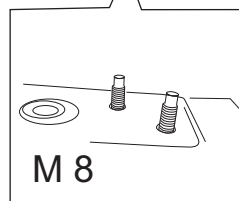
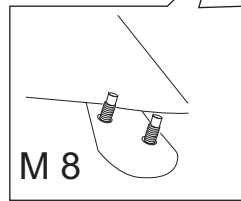
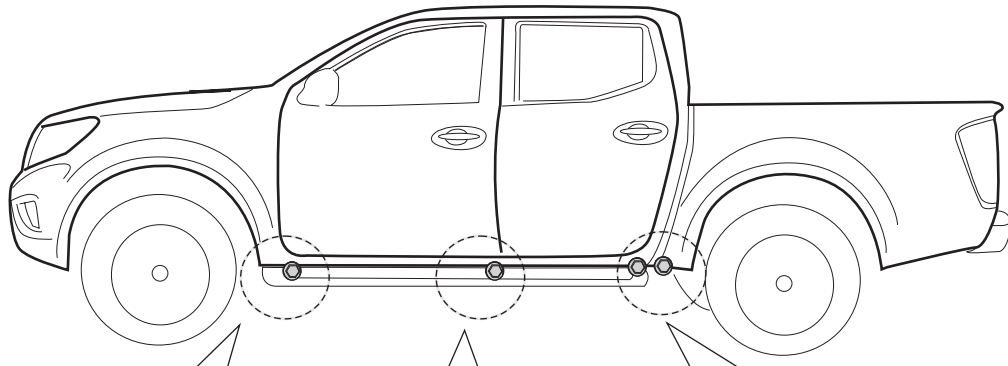

X6
PER SIDE

Ohne Fahrzeugschrauben
Without vehicle screw

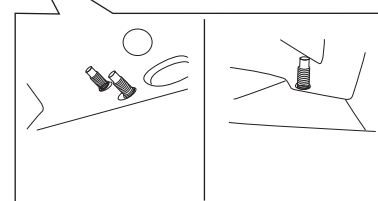
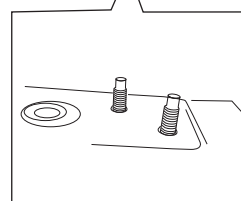
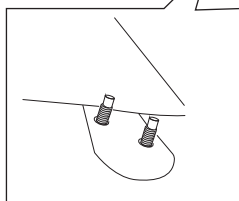
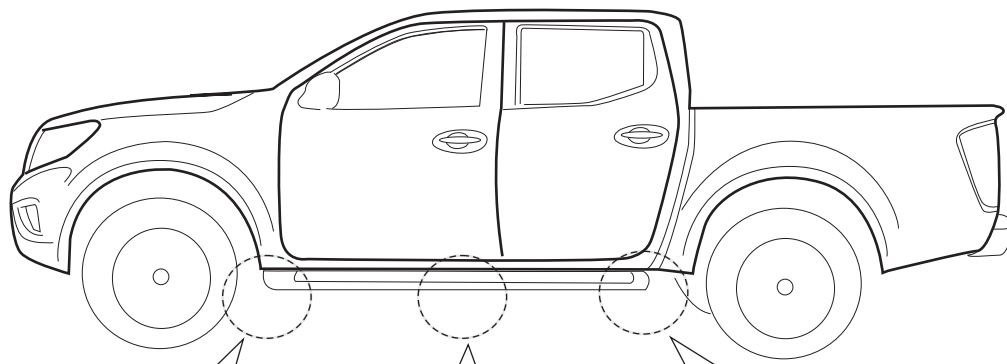

2

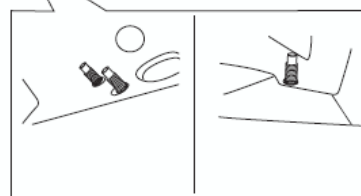
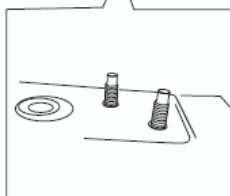
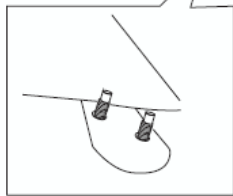
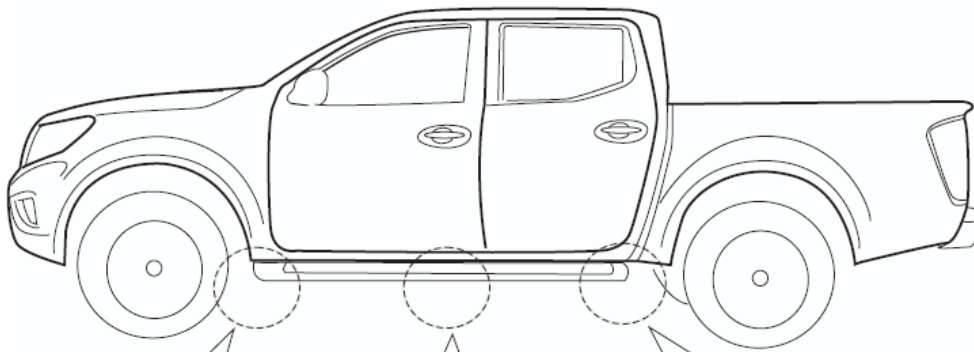

Mutter M8
Nut M8

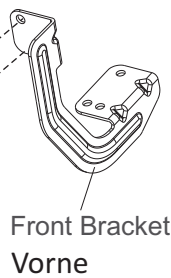

Mutter M8
Nut M8

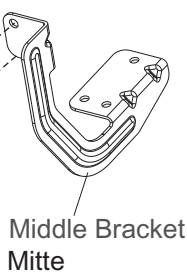

Mutter M8
Nut M8

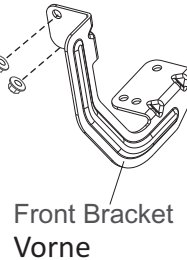

Mutter M8
Nut M6

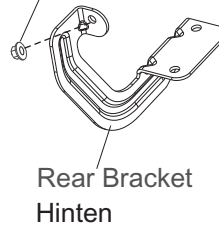

Mit Fahrzeugschrauben
With vehicle screw

Mutter M8
Nut M8

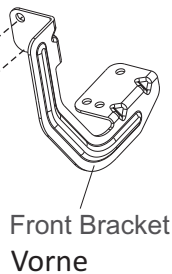

Mutter M8
Nut M8

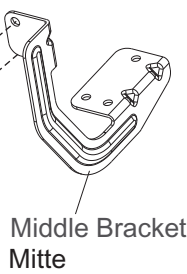

Mutter M8
Nut M8

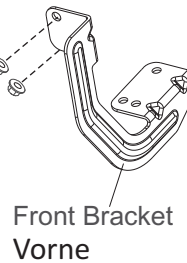

Mutter M8
Nut M6

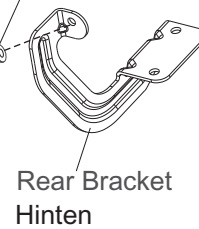

Ohne Fahrzeugschrauben
Without vehicle screw

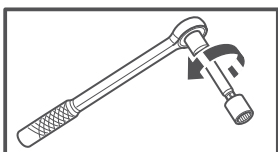

12 Nm.

X6

Pro Seite / Per Side

3

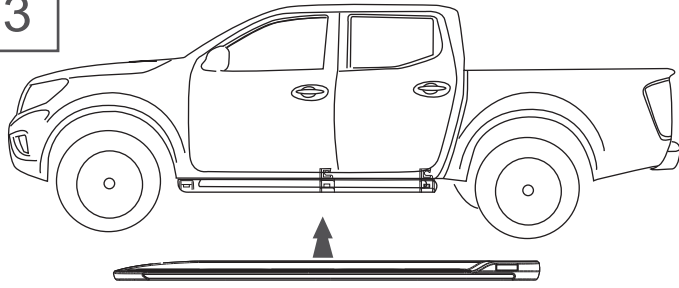

Achten Sie darauf, die Lackierung nicht zu beschädigen.
Ziehen Sie die lose Schrauben zwischen den Halterungen
und Fahrzeug für jede Position der Halterung fest.



BE CAREFUL NOT TO DAMAGE THE PAINT WORK
TIGHTEN LOOSE SCREW BETWEEN BRACKET
AND VEHICLE FOR EACH POSITION OF BRACKET

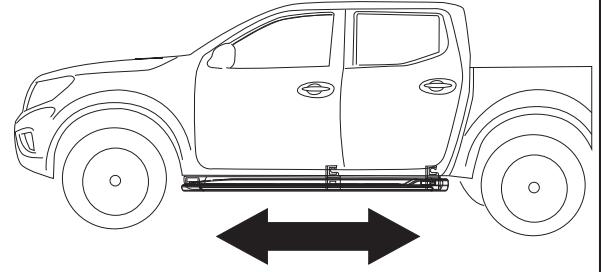
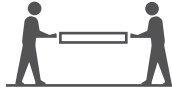

Seitenstufe auf Lochposition anpassen
ADJUST SIDE STEP NISSAN HOLE POSITION

Achtung: Fahrzeug Seitenleiste ist links und rechts spiegelgleich

NOTE : VEHICLE NOT SHOWN FOR CLARITY
LHS SHOWN RHS SYMETRICALLY OPPOSITE

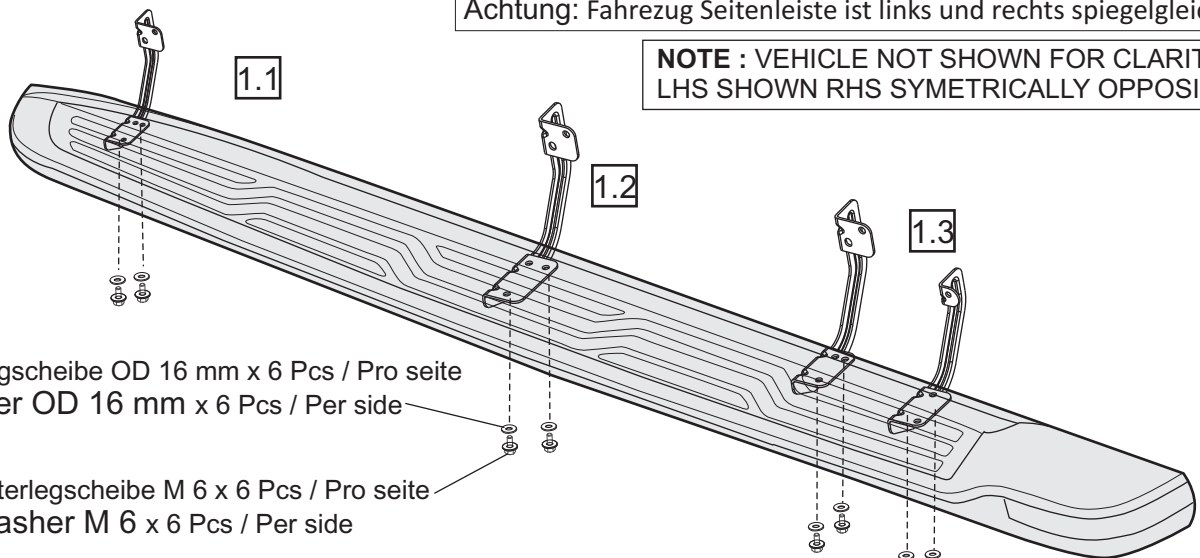

Unterlegscheibe OD 16 mm x 6 Pcs / Pro Seite
Washer OD 16 mm x 6 Pcs / Per side

Unterlegscheibe M 6 x 6 Pcs / Pro Seite
Washer M 6 x 6 Pcs / Per side

- REMARK : 1.) Nach Anpassen der Seitenleiste
an den Löchern, die Schrauben der Klemme
und Seitenleiste anziehen
2.) Alle Schrauben anziehen
3.) Film von der Chromleiste entfernen

- REMARK : 1.) AFTER ADJUST SIDE STEP FOR NISSAN HOLE THEN
TIGHTEN LOOSE SCREW BETWEEN BRACKET AND SIDE STEP
2.) TIGHTEN SCREW FOR ALL POSITION
3.) FINALLY, PLEASE PEEL CLEAR FILM OFF FROM PVC CHROME STRIP.

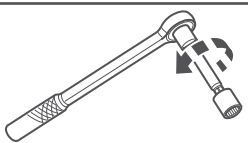

8 Nm

X 6

Pro Seite / Per Side

1.1

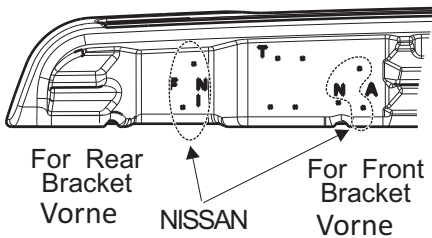

For Rear
Bracket
Vorne

NISSAN

For Front
Bracket
Vorne

1.2

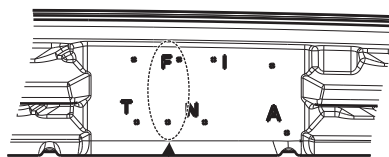

NISSAN

(For Middle
Bracket)
Mitte

1.3

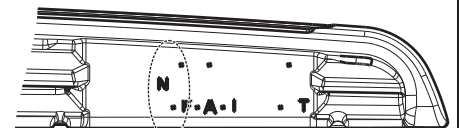

NISSAN

(For Front
Bracket)
Vorne