

MISUTONIDA
 italian style accessories **4x4**

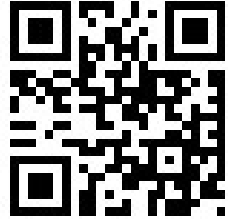

**TOYOTA HI-LUX DOUBLE CAB
 2016**



60 Min.

Item Code

Codice Articolo

Référence Article

P/410/IX

GB

**STAINLESS STEEL
 SIDESTEPS**

ITA











**PEDANA SOTTOPORTA
 IN ACCIAIO INOX**

FR

**MARCHEPIEDS
 EN ACCIER INOX**

TOYOTA HI-LUX DOUBLE CAB 2016

Part List
 Lista della bulloneria
 Liste des pièces

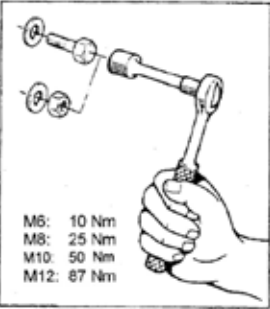
A  TE M10X25 x 8	B  Ø 10 x 8	C  Ø 10 x 8	D  M10 x 8	E  M 8 x 2
F  TE M8X30 x 4	G  BIG Ø 8 GRANDE x 8 GRAND	H  Ø 8 x 8	I  P/410/B x 2	L  P/410/C x 2
 Cappelletti M10 x 16				
				 <p>M6: 10 Nm M8: 25 Nm M10: 50 Nm M12: 87 Nm</p>

TOYOTA HI-LUX DOUBLE CAB 2016

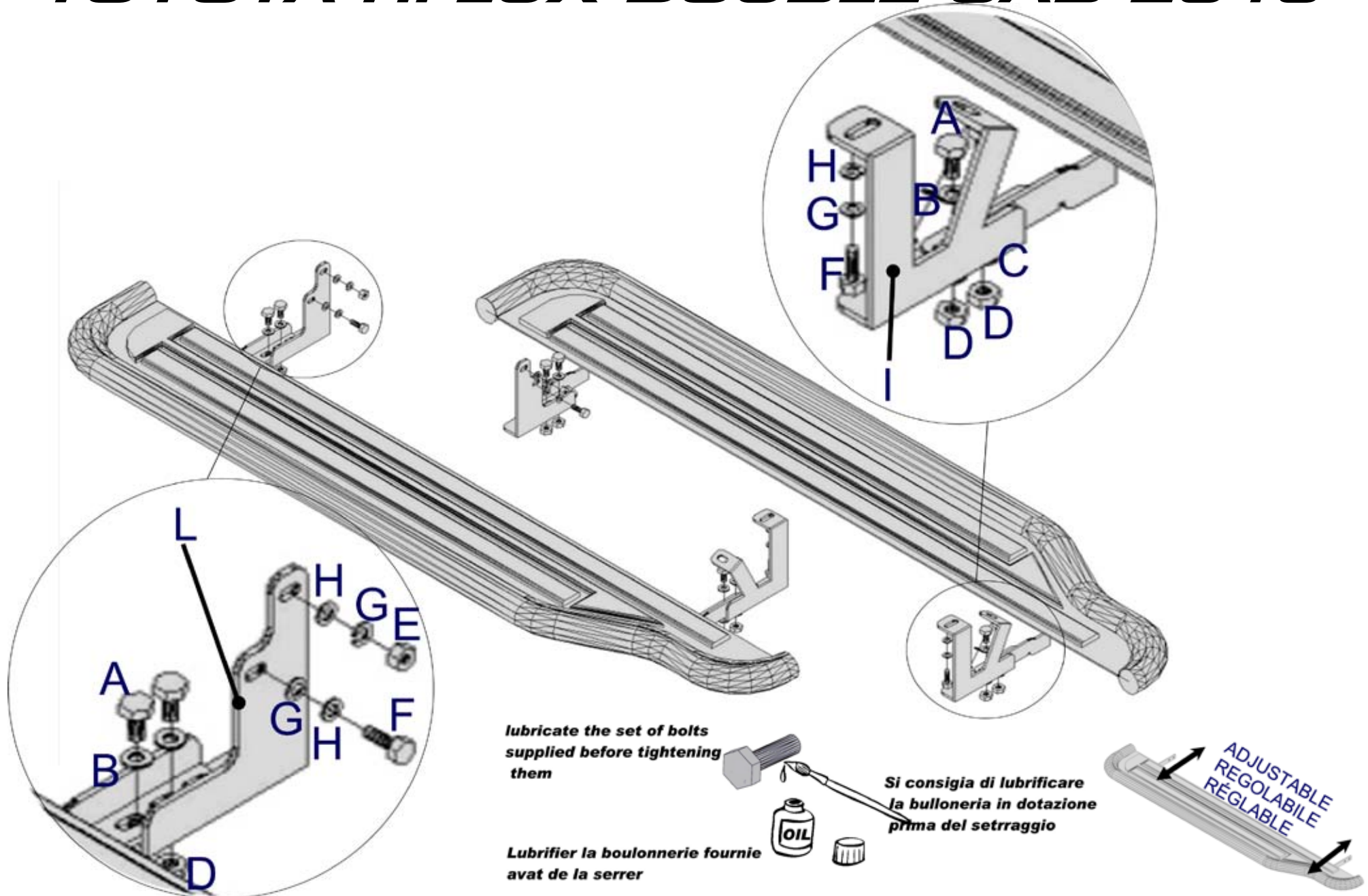

*lubricate the set of bolts
supplied before tightening
them*

*Si consiglia di lubrificare
la bulloneria in dotazione
prima del settaggio*

*Lubrifier la boulonnerie fournie
avant de la serrer*

**ADJUSTABLE
REGOLABILE
RÉGLABLE**



Date Data Date Datum	Item Code Cod.Articolo Réf. Article Artikelbezeichnung	Vehicle model Modello Veicolo Modèle de Voiture Fahrzeugmodell
06/06/16	P/410/IX	HI-LUX DOUBLE CAB 2016

Document checked and approved by
Documento controllato ed approvato da
 Document contrôlé et approuvé par
 Dokument überprüft und freigegeben durch

BOTTA PIETRO



7



8



9



10

Date Data Date Datum	Item Code Cod.Articolo Réf. Article Artikelbezeichnung	Vehicle model Modello Veicolo Modèle de Voiture Fahrzeugmodell
06/06/16	P/410/IX	HI-LUX DOUBLE CAB 2016

Document checked and approved by
Documento controllato ed approvato da
 Document contrôlé et approuvé par
 Dokument überprüft und freigegeben durch

BOTTA PIETRO