

**MISUTONIDA**  
 italian style accessories **4x4**

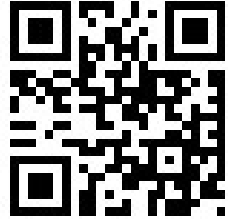

**TOYOTA HI-LUX DOUBLE CAB  
 2016**



Item Code	<b>GPO/410/IX</b>
Codice Articolo	<b>DSP/410/IX</b>
Réference Article	

**GB**

STAINLESS STEEL OVAL SIDE PROTECTIONS/DESIGN SIDE PROTECTIONS

**ITA**











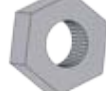

GRAN PEDANA OVALE/PROTEZIONI LATERALI DESIGN IN ACCIAIO INOX

**FR**

GRAND MARCHEPIED OVALE/ PROTECTIONS LATERALES DESIGN EN ACCIER INOX

# TOYOTA HI-LUX DOUBLE CAB 2016

Part List  
 Lista della bulloneria  
 Liste des pièces

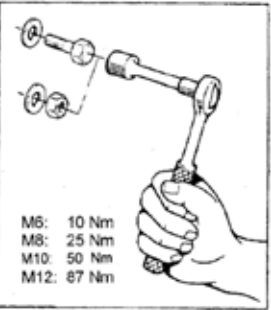
<b>A</b>  <b>TE M10X25</b> x 8	<b>B</b>  <b>Ø 10</b> x 8	<b>C</b>  <b>Ø 10</b> x 8	<b>D</b>  <b>M10</b> x 8	<b>E</b>  <b>M 8</b> x 2
<b>F</b>  <b>TE M8X30</b> x 4	<b>G</b>  <b>BIG Ø 8</b> <b>GRANDE</b> <b>GRAND</b> x 16	<b>H</b>  <b>Ø 8</b> x 16	<b>I</b>  <b>TE M8X20</b> x 8	<b>L</b>  <b>GPO/410/A</b> x 4
<b>M</b>  <b>P/410/B</b> x 2	<b>N</b>  <b>P/410/C</b> x 2	 <b>Cappelletti</b> <b>M10</b> x 16	 <b>Cappelletti</b> <b>M 8</b> x 8	 <p>M5: 10 Nm            M8: 25 Nm            M10: 50 Nm            M12: 87 Nm</p>

# TOYOTA HI-LUX DOUBLE CAB 2016

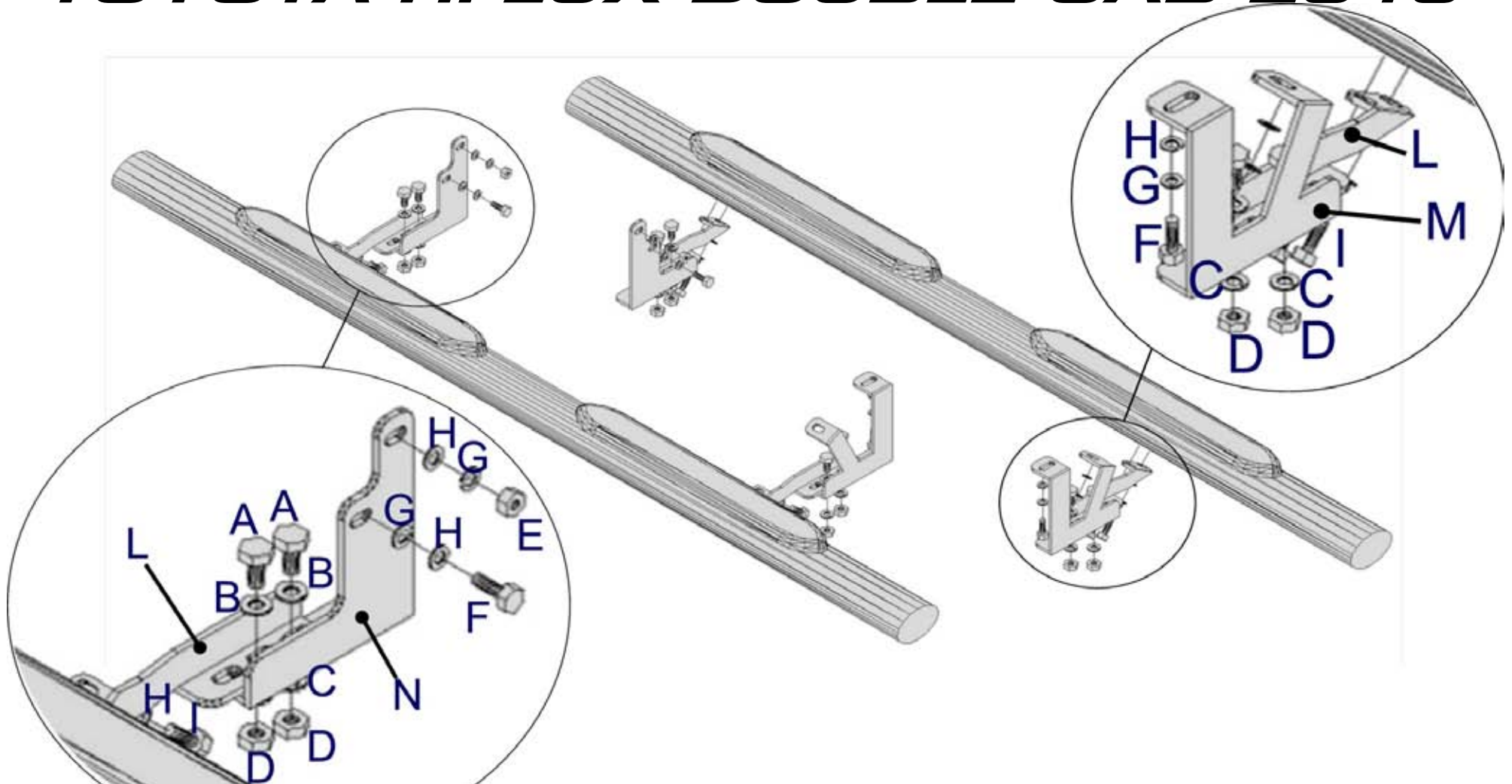

*lubricate the set of bolts  
supplied before tightening  
them*

*Lubrifier la boulonnerie fournie  
avant de la serrer*



*Si consiglia di lubrificare  
la bulloneria in dotazione  
prima del settaggio*





1



2



3



4



5



6

Date Data Date Datum	Item Code Cod.Articolo Réf. Article Artikelbezeichnung	Vehicle model Modello Veicolo Modèle de Voiture Fahrzeugmodell
06/06/16	DSP/410/IX GPO/410/IX	HI-LUX DOUBLE CAB 2016

Document checked and approved by  
**Documento controllato ed approvato da**  
*Document contrôlé et approuvé par*  
*Dokument überprüft und freigegeben durch*

**BOTTA PIETRO**



Date Data Date Datum	Item Code <b>Cod.Articolo</b> Réf. Article Artikelbezeichnung	Vehicle model <b>Modello Veicolo</b> Modèle de Voiture Fahrzeugmodell
<b>06/06/16</b>	DSP/410/IX GPO/410/IX	<b>HI-LUX DOUBLE CAB 2016</b>

Document checked and approved by  
**Documento controllato ed approvato da**  
 Document contrôlé et approuvé par  
 Dokument überprüft und freigegeben durch

**BOTTA PIETRO**